









Operation Manual for the PD2 Single Channel Series Power Supply Units for LED Lighting PD2-1012/1024/3012/3024/5024



1. Safety Precautions ***Be sure to read prior to using the product.**

Thank you for purchasing this Power Supply for LED Illumination. Please read this Operating Manual before using the product, and follow its instructions to ensure safe operation. We also recommend that you keep the Operating Manual together with the product for later reference. Please observe the items marked with the  Warning,  Caution, symbols to prevent injury, electric shock, and other accidents.



 Warning	Indicates a potentially hazardous situation which, if not avoided, could result in death or serious injury.
 Caution	Indicates a potentially hazardous situation which, if not avoided, may result in injury or property damage.

Warning

- (1) Always use one of the following power cables for the PD2-3012, PD2-3024, and PD2-5024.
100 to 120 V range: SVT type, AWG 18, length: 3 m max. , dielectric strength: 125V min. (Note: This power cable is required for compliance with UL)
200 to 240 V range: H05W-F type, AWG 18, length: 3 m max. , dielectric strength: 250 V min. (Note: This power cable is required for compliance with EU)
- (2) Plug in or unplug the power cable after turning OFF the supplied power. Otherwise, fire or electric shock may occur. Plug the power cable directly into the outlet.
Do not plug the power cable into an extension cord or into a multiple-type outlet that have another power cables. Otherwise, fire or electric shock may occur.
Always unplug the unit and peripheral devices from the outlet first before connecting or disconnecting the unit. Damage to the power cord may result in fire or electric shock. 
- (3) If the unit is damaged, turn it OFF, unplug the power cord from the outlet, and contact the company from which you purchased the product. Continued use of the unit may result in fire or electric shock.
- (4) Follow the operating procedures stipulated for the product in this manual. Failure to do so may result in diminished protection capabilities.
- (5) The unit operates at a power supply voltage of 100 to 240 V AC. The supplied power cable, however, is for use with 100 V. If the unit is to be used at 200 V or above, use a 200-V power cable for the 30- and 50-W models.
- (6) When the rubber feet are removed to mount the unit in a system rack or case, the portion of the M3 screws penetrating the case must be less than 5 mm long. If this portion is longer, internal components may become short-circuited.
- (7) Do not open the cover of the Power Supply for LED Illumination.
There are high-voltage parts inside. Opening the cover may result in electric shock. 

<p>(8) Do not touch the AC power plug with wet hands. To do so may result in electric shock.</p>	
<p>(9) Ground the power supply. Ground the FG terminal of 10-W models with 0.5 to 1.25-mm² wires (AWG20 to AWG16) wire if there is a possibility that an operator might touch the power supply unit and a metallic frame with a different electrical potential at the same time. If the frame is not grounded and has electric potential, it is better to connect the FG terminal of the product to the FG terminal of the frame. (Use a 3-prong AC power cable with a ground terminal to ground 30- and 50-W models.)</p>	
<p>(10) If smoke appears, the product becomes abnormally hot, unusual smells or sounds are generated, or any other abnormality occurs, stop using the product immediately and turn OFF the power.</p>	

 **Caution**

<p>(1) Illuminators become very hot during use. For this reason, do not use them in a closed space. If it is necessary to use them in a closed space, provide sufficient cooling in the form of fans or other cooling devices.</p>	
<p>(2) Install the product in places with the following conditions:</p> <ul style="list-style-type: none"> · Horizontal, stable places with little vibration · Places with good ventilation and little dust · Places that are not subject to sudden temperature changes · Places stipulated in the specifications, i.e., places located away from water faucets, water heaters, humidifiers, coolers, heaters, or stoves. · Places that do not have water-containing objects nearby · Places where the power switch is readily accessible to ensure that the power can be turned OFF immediately in an emergency. · Always use the product in a place where there is a ground connection. 	
<p>(3) Observe the following items for the Power Supply:</p> <ul style="list-style-type: none"> · Provide a dedicated power source with stable voltage. Wiring the product from the same power source as a large device, such as a motor or an inverter, may result in malfunction. · Disconnect the power plug when the product is not to be used for an extended period of time. · Do not place the power cable near a heat-generating device, and do not allow the power cable to be scratched. · In the event of a thunderstorm, do not touch the product case and the power plug. 	

2. Overview

This power supply is for exclusive use with LED lighting made by CCS.

1. Dimming can be controlled in internal mode from the intensity control knobs on the front panel of the PD2 or in external mode using a PLC, microcomputer, or other device.
2. The external ON/OFF control is available in PD2.
3. PD2 models can supply the following power specifications.
 - PD2-1012: 12 VDC, 0.79 A (9.5 W)
 - PD2-1024: 24 VDC, 0.38 A (9 W)
 - PD2-3012: 12 VDC, 2.3 A (28 W)
 - PD2-3024: 24 VDC, 1.16 A (28 W)
 - PD2-5024: 24 VDC, 1.92 A (46 W)

3. Operating Procedure

Turning ON lighting

1. Check the power supply switch to make sure it is turned OFF (○ position).

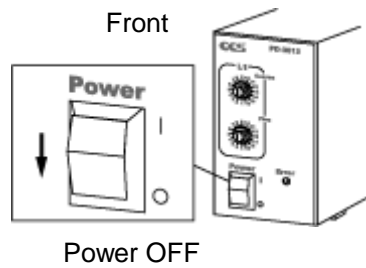

Note: The illustration shows the PD2-3012/24. All other models operate the same way.

2. Connect the LED lighting to the power supply.
3. Plug the AC power cable of the power supply into an outlet.
4. Connect an external control connector if it is the case to use external control.

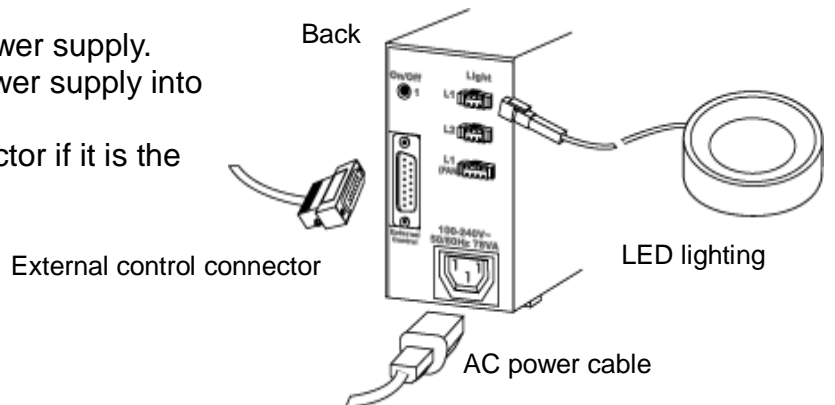

5. Turn ON the power supply switch (| position).

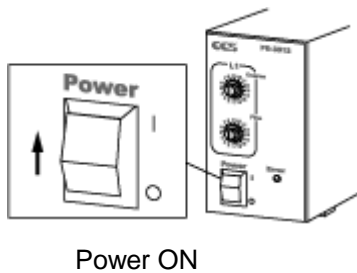

6. Use the intensity control knobs to set lighting intensity.

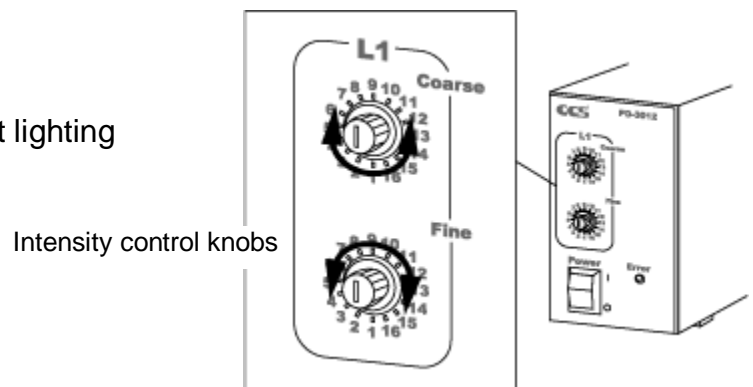

Adjusting lighting intensity

- Turn the intensity control knobs on the front panel of the PD2 to set the lighting intensity.
Each front panel knob controls dimming in 16 steps. With 16 fine steps for every coarse step (16 steps), the result is up to 256 steps of extremely fine dimming control.

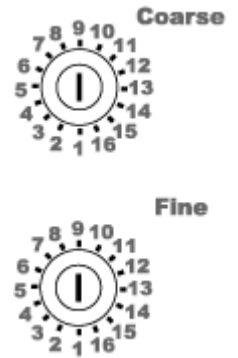

Turning OFF lighting

- Turn OFF the power supply switch (○ position).

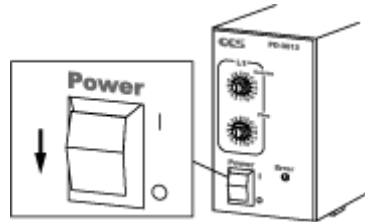

Power supply OFF

External control

External control

- A Dsub terminal is provided on the rear panel of the PD2 for external control. The PD2 can be controlled externally using parallel bit control.

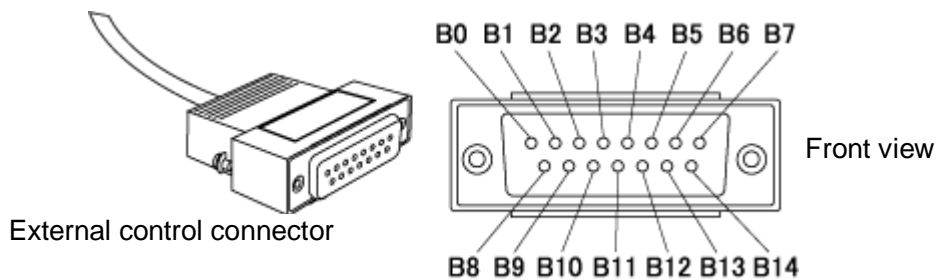

2. Pin bit arrangement for external control terminals

Bit	B0	B1	B2	B3	B4	B5	B6	B7	B9	B9	B10
Structure	Dimming bit (0 to FF)								EXT	WR	ON1

A driver IC or an open collector outputs a signal to each terminal and the external control signals are input to the PD2 at CMOS level.

- The EXCB2-B3 is an optional external control cable manufactured by CCS.
- The PD2 support the following types of external control.
 - External and manual dimming control selection
 - Dimming settings
 - Lighting ON/OFF control
 - Overcurrent protection signal monitoring

External control

1. Connect the external control cable to the power supply.
(Also connect the lighting and any other devices.)

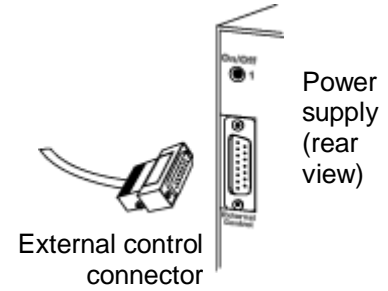

2. Input the desired control signal from the external control cable.

External and manual dimming control selection

Set bit B8 of the Dsub external control connector to Low to set the PD2 to external control mode. Dimming from the front panel is disabled in this mode. Set bit B8 to HIGH to enable dimming from the front panel and disable externally controlled dimming.

Dimming settings

Set the 8 bits from B0 to B7 as well as B9 to control dimming. Specify up to 256 dimming steps using bits B0 to B7 and send the write signal to write bit B9 to write the dimming data to the PD2. Keep the write signal Low for at least 300 μ s to write the data, and switch the signal back to HIGH after the minimum write time has elapsed to stop writing data.

Note: Dimming settings are enabled only as long as the power supply remains ON and will be lost when the power supply is turned OFF.

Lighting ON/OFF control

After you have selected the dimming level, use the ON/OFF signal at bit 10 to control when the lighting turns ON and OFF.

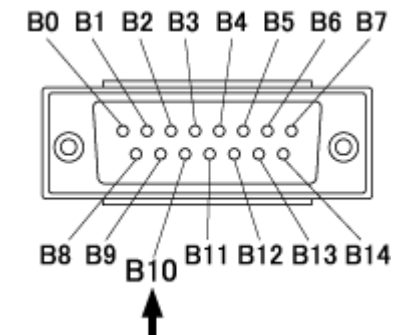
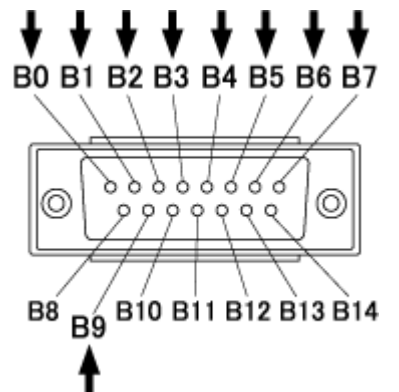
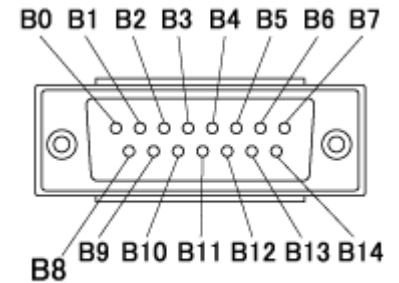
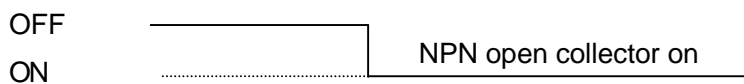

Write sequence

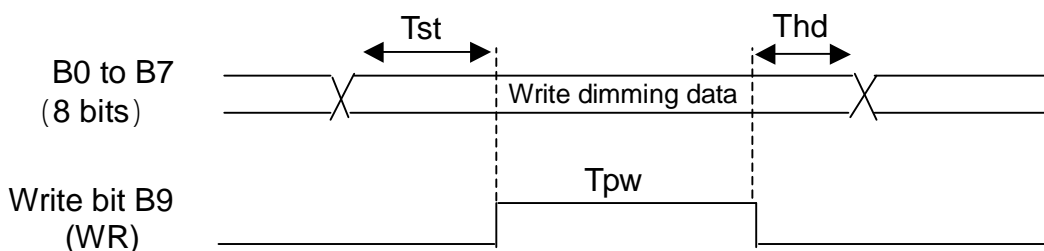

Tst	100 μ s
Tpw	300 μ s
Thd	100 μ s

Dimming data (B0 to B7) is output in negative logic (Low: 1)
The write bit is output. (Data is written on the falling edge.)

Manual ON/OFF control

1. In manual mode, the external ON/OFF control is available for the illuminator.

2. Insert the phone plug into the phone jack to send the ON/OFF control signal for manual control (internal ON/OFF control).

Note: Control is limited strictly to turning lighting ON and OFF.

Note: This option is not available when dimming is externally controlled.

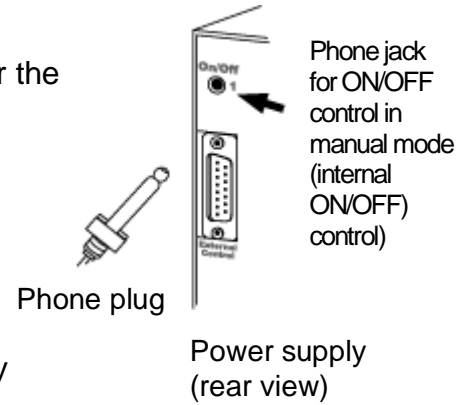

Phone jack (Ø3.5) signal line

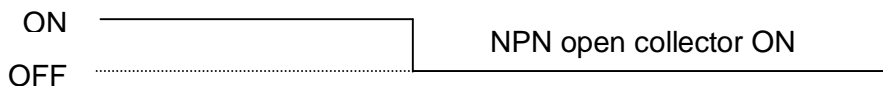

Overcurrent protection

Overcurrent protection output

The overcurrent protection output is a monitoring signal that becomes active when overcurrent is detected. It is output from bit B13. Output circuit is an open collector, with negative logic (active Low).

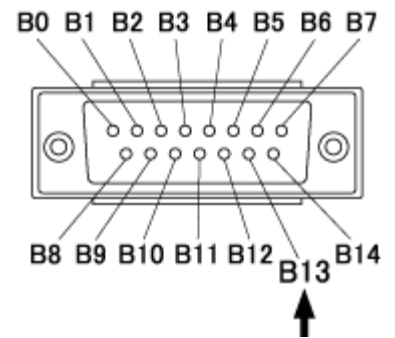

The PD2 output stops if lighting current consumption (total of all channels) exceeds 107% of the rated current consumption. Also, the red error indicator on the front panel of the power supply will light and output cannot be resumed until the power supply is restarted.

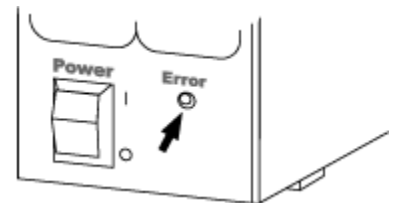

4. Connectors (cable plug connectors are not included)

1. Output connectors: SM connectors (JST)

Pin number	12 V output	24 V output	12 V with fan	24 V with fan
1	OUT + (12 V)	OUT + (24 V)	NC	OUT + (24 V)
2	OUT -	NC	OUT + (12 V)	NC
3		OUT -	OUT -	OUT -
4			Fan GND	Fan GND
Connector	SMP-02V-BC	SMP-03V-BC	SMP-04V-BC	SMP-04V-BC

With fan: Output connector for lighting L1 (FAN)

2. External control connectors: 15-pin D-sub male with M2.6-mm screws
Use a shielded cable of 3 m or less for the control line.

Pin number	Optional cables		Signal
	Cable color	Line color	
1	Black	–	Dimming B0 (LSB)
2	White	–	Dimming B1
3	Red	–	Dimming B2
4	Green	–	Dimming B3
5	Yellow	–	Dimming B4
6	Brown	–	Dimming B5
7	Blue	–	Dimming B6
8	Purple	–	Dimming B7 (MSB)
9	Gray	–	External control (INT/EXT) B8
10	Pink	–	Dimming data write (WR) B9
11	White	Black	Lighting control (OFF/ON) B10
12	Red	Black	-
13	Green	Black	-
14	Yellow	Black	Overcurrent protection (OCP) B13
15	Brown	Black	Signal GND

Chart legend:

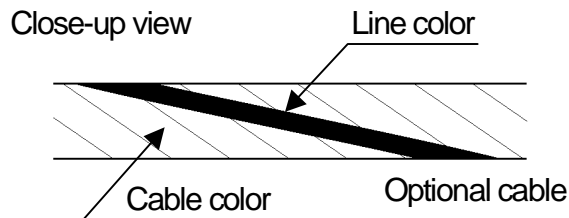

Optional cable for external control:
EXCB2-B3 (cable length: 3 m, with one side of the cable cut)

3. Phone jack (Ø 3.5) for manual ON/OFF control

Lighting can be turned ON and OFF manually when the phone plug is inserted into the phone jack. The LED lighting will turn ON when the signal is connected to ground and will turn OFF when the signal is disconnected from ground.

Phone plugs

	Terminal	Signal
1	Inside	ON/OFF signal
2	Outside	GND

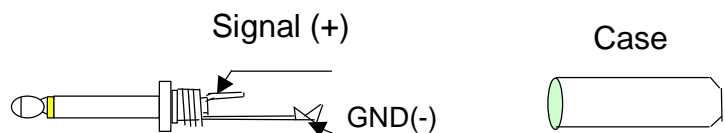

Contact your nearest CCS representative if you need to extend the control signal cable or operate in an extremely noisy environment. Cables should not be extended more than 3 m. Potentially harmful noise may be eliminated by installing a 0.01 to 0.1- μ F capacitor between the signal and ground to ensure proper operation of this product. Phone plugs are not included with the power supply kit, but optional 3-m cables with plugs are available. (Cable model number: NFCB2-3, with a white wire for the signal (+) and a black wire for ground (-))

5. PD input circuit (negative logic)

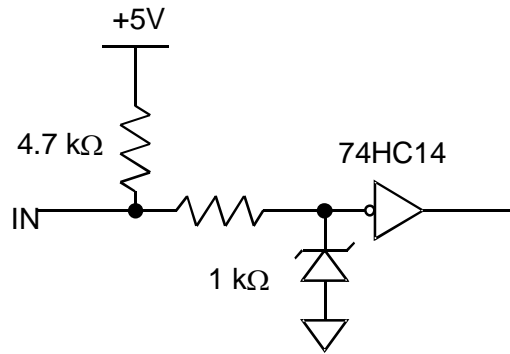

Dimming data: B0 to B7
Control signals: EXT, WR, and ON
Output using a driver IC or NPN open collector
(Maximum allowable input voltage: 12 V)

6. Recommended control signal drive circuits: open collector photo-coupler, photo-MOS relay

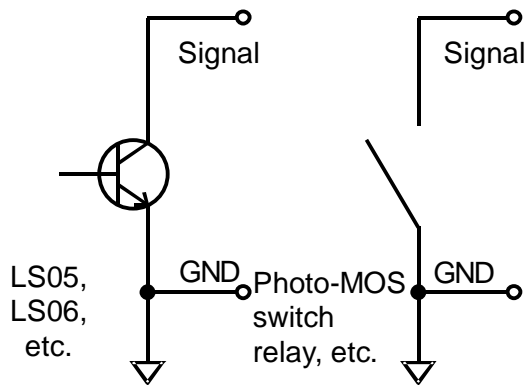

When using the PD2 in a noisy environment, we recommend that you isolate the signal and ground lines from the control unit with photo-couplers or photo-MOS relays. Any element that supplies around 10 mA can be used to drive the circuit.

7. Appearance (mm)

PD2-1012/1024

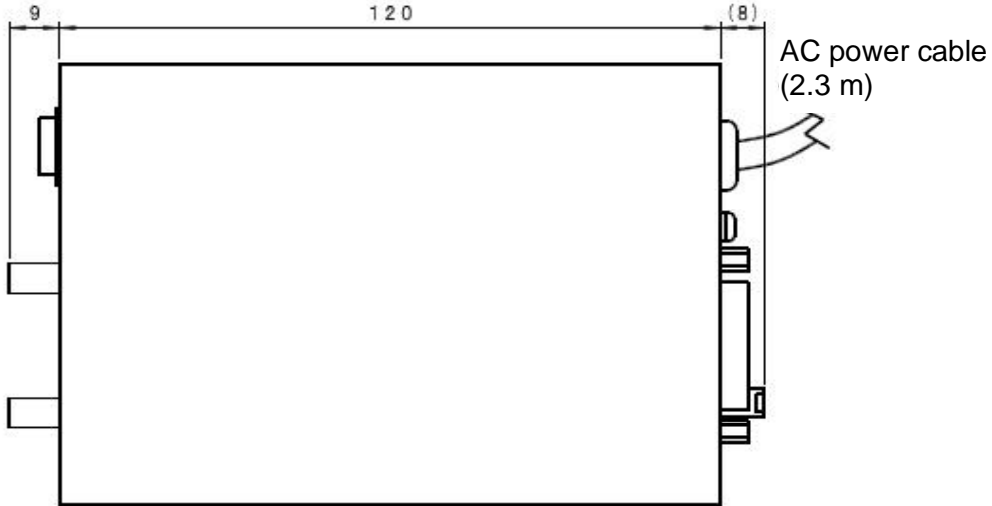

Power switch

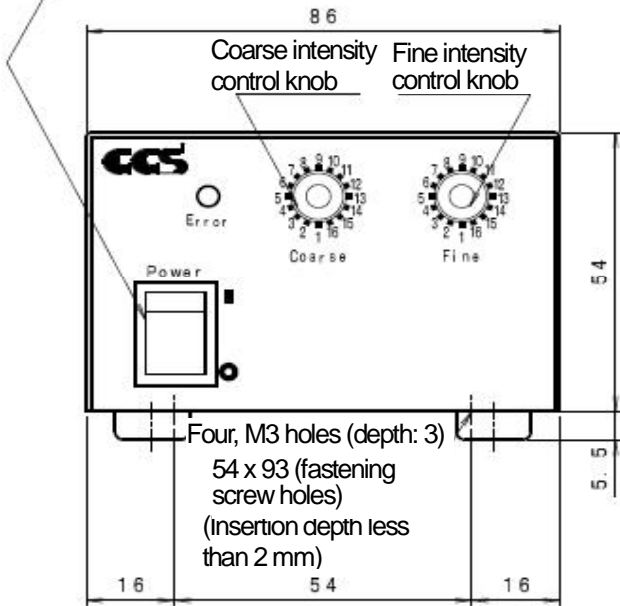

Output Connectors

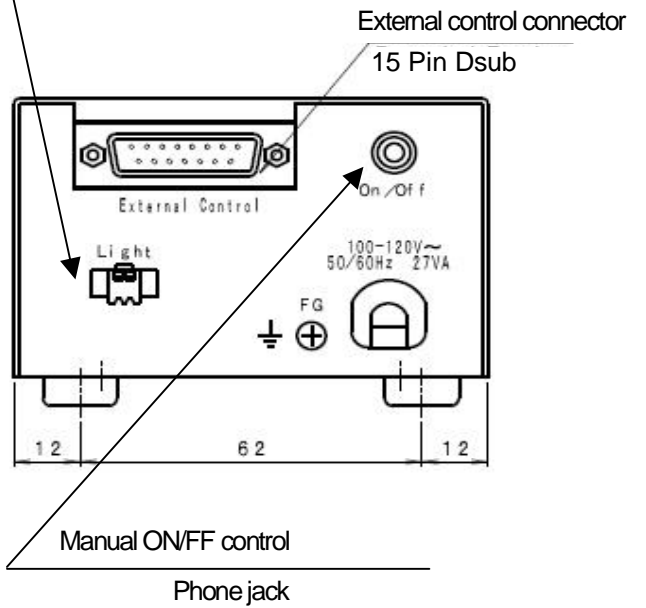

PD2-3012/3024

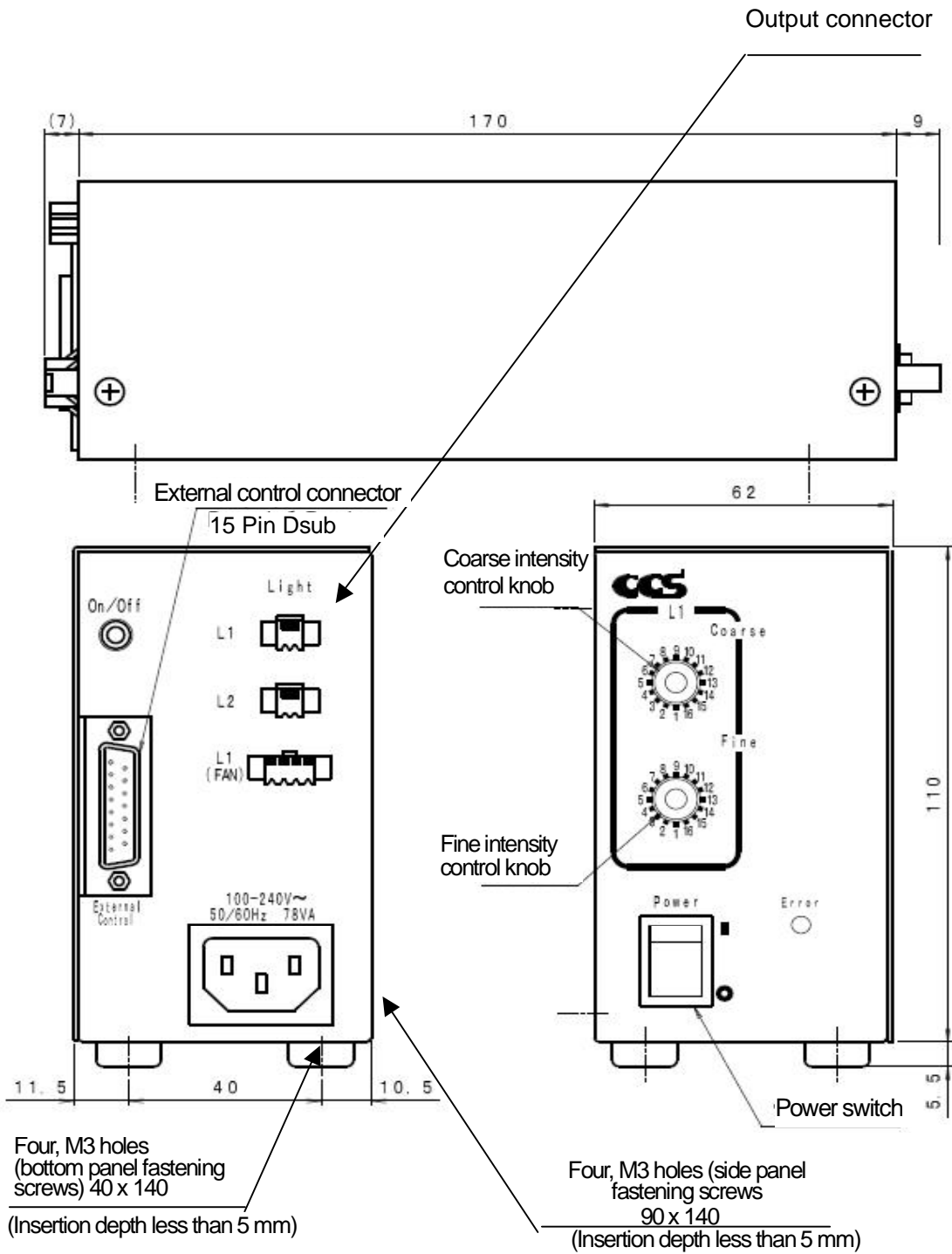

Supplied AC power cable (2 m)

8. Important

(1)	<p>Suppress heat generation in the LED illuminators that are used.</p> <ul style="list-style-type: none"> The service life of LED illuminators will decrease if they are used at high temperatures. Dimming the illuminators 50% when used continuously can achieve stable extended performance. Using the illuminators only when capturing an image (i.e., strobing) will suppress heat generation and produce the most stable conditions for use.
(2)	<p>Do not extend the light output cable to more than 5 m. Otherwise the voltage on either end of the lighting will decline because of the voltage drop due to the DC resistance of the cable. Dimming decreases since the voltage supply to the light does not reach the rated voltage even at 100% dimming.</p>
(3)	<p>Bundling the camera cable and the power cable together may adversely affect screen images.</p>
(4)	<p>Color camera with white LEDs</p> <ul style="list-style-type: none"> The amount of light (brightness) and color may vary with the temperature of the lighting when using continuously. Adjust the white balance of the camera again about one hour after switching ON the power. The power supply can be used for strobing as soon as the power is turned ON.
(5)	<p>Use cable within the applicable range for external control. A shielded cable shorter than 3 m should be used for the control line to lessen the chances of picking up noise.</p>
(6)	<p>To operate CCS lighting without cooling fans, use ON/OFF control to turn OFF the lighting when it does not have to be lit in order to lower the temperature of the lighting.</p>
(7)	<p>Although the power supply unit has an overcurrent protection circuit to protect the driver transistor, do not short the power supply output.</p>

9. Specifications

Models	PD2-1012, PD2-1024, PD2-3012, PD2-3024, PD2-5024,
Power supply (See notes 1)	(100 to 120 VAC) -15% to +10% (50/60 Hz): PD2-1012, PD2-1024 (100 to 240 VAC) -15% to +10% (50/60 Hz): PD2-3012, PD2-3024, PD2-5024
Maximum capacity (See notes 2)	27 VA max. (PD2-1012, PD2-1024) 78 VA max. (PD2-3012, PD2-3024) 122 VA max. (PD2-5024)
Output	12 VDC: PD2-1012, PD2-3012 24 VDC: PD2-1024, PD2-3024, PD2-5024 (Output+/between circuit GND)
Dimming control	Dimming method: Approximately 63 Hz pulse duty control Internal control: Front panel rotary switch (256 step control) External control: Parallel signal control (15-pin Dsub external control connector)
Power cable	Up to 3 m long AC power cable with a ground terminal (PD2-3012, PD2-3024 and PD2-5024) Up to 1.8 m long 2- flat prong AC power cable (PD2-1012 and PD2-1024)
Connectors	Lighting output: SMP-02V-BC, SMP-03V-BC (female, JST) Lighting output with fan: SMP-04V-BC (female, JST) External control: 15-pin D-sub male (millimeter screws) Manual on/off control: Phone jack Ø3.5)
Start time	0.5 s typ.

Output overcurrent protection (See notes 3)	Operates at 107% of the rated current The Error indicator (red) on the front panel is lit when overcurrent is detected. This latch-type protection is restored by restarting the power supply.		
Insulation/dielectric strength	Between input and output connectors and between input connector and frame ground:	2,000 VAC for one minute (10 mA)	
	Between output connector and frame ground:	500 VDC, 20 M min 500 VDC, 20 M min	
Applicable standards	CE marking (EMC: EN61326, LVD: EN61010-1: 2001) (PD2-3012 and PD2-3024 only)		
Operating environment	<ul style="list-style-type: none"> · Temperature: 0 to 40 °C, humidity: 20 to 85% (with no condensation) · Altitude: 2,000 m max. · Pollution level: 2 · Protective ground class I · Installation category II (restricted to use in indoor environments) 		
Storage environment	Temperature: -20 to 60°C, humidity: 20 to 85% (with no condensation)		
Case	SECC t1.0, paint color N3 (leather-tone finish)		
Cooling method	Natural air cooling		
Ratings (See notes 1, 2, and 3.)	Model	Input	Output
	PD2-1012	100 to 120 VAC (50/60Hz), 27 VA	12 VDC, 9.5 W
	PD2-3012	100 to 240 VAC (50/60Hz), 78 VA	12 VDC, 28 W
	PD2-1024	100 to 120 VAC (50/60Hz), 27 VA	24 VDC, 9 W
	PD2-3024	100 to 240 VAC (50/60Hz), 78 VA	24 VDC, 28 W
	PD2-5024	100 to 240 VAC (50/60Hz), 122 VA	24 VDC, 46 W
Dimensions	PD2-1012, PD2-1024:	86 x 120 x 54 mm (WxDxH)	
	PD2-3012, PD2-3024:	62 x 170x 110 mm (WxDxH)	
	PD2-5024:	62 x 230 x 110 mm (WxDxH)	
Weight	PD2-1012, PD2-1024:	0.6 kg max.	
	PD2-3012, PD2-3024:	1 kg max.	
	PD2-5024:	1.3 kg max.	
Accessories	2-m long 3-prong AC power cable with ground terminal (PD2-3012, PD2-3024, and PD2-5024 only) Manual, Warranty (external control connector not included)		

Notes

1: The operating voltage range is -15% to +10% of the input voltage.

2: Do not exceed the maximum wattage for the total number of circuits.

3: The overcurrent protection circuit is activated when the rated load is exceeded.

(Power supply operation is stopped by internal circuits. Restart the power supply to restore operation.)

10. Care and Handling

Warning

- Turn OFF the Power Supply and unplug it from the outlet before handling.

Caution

- Do not scratch the unit by handling it with a hard object.
- Do not let water or cleanser enter the unit.
- Do not use cleansers or chemical agents other than those listed below.

For cleaning, dampen a soft cloth with diluted neutral cleanser, wring out the cloth, and gently wipe off the unit. Use another soft cloth to wipe the unit dry. To clean the case and protective sheet, dampen a soft cloth with a diluted neutral cleanser, wring out the cloth, and gently wipe off the unit. Use another soft cloth to wipe the unit dry.

■ Warranty

1 Duration of warranty

The duration of the product warranty shall be one year from the day of product delivery.

2 Extent of warranty

- (1) If a fault or defect attributable to CCS becomes apparent during the duration of the warranty, CCS will in good faith ship a replacement, or replace or repair the defective part of the product free of charge. The following cases, however, are not covered by the warranty.
 - Faults or damage that occur due to conditions, environments, handling, or usage other than those described in the Operating Manual and specifications.
 - Faults or damage that occur due to modification of structure, performance, specifications, etc., by a party other than CCS.
 - Faults or damage that occur due to use of the product other than for its designed purpose.
 - Faults or damage that occur due to reasons scientifically and technically unforeseen at the time the warranty with CCS was entered into or at the time of shipment.
 - Faults or damage that occur due to natural or human causes not attributable to CCS, such as saltwater air damage, gas damage, earthquakes, floods, fire, lightning, or armed conflicts.
- (2) This warranty is limited to this product purchased from CCS. Any consequential or other damage induced by a fault or defect in the product is not covered by the warranty.
- (3) CCS shall not be responsible for any damages suffered by the customer because of late delivery of the product due to a natural disaster or other causes not attributable to CCS.
- (4) If CCS does bear responsibility for damage, compensation shall not exceed the cost of replacing the product.
- (5) CCS shall bear no responsibility in any way for damages that occur due to handling as part of export controls.
- (6) This CCS product is designed and produced for use in the conditions and for the purposes described in the Operating Manual and specifications. Therefore, the warranty does not apply to nuclear energy control systems, aerospace systems, vehicles, railroad systems, medical equipment, or other applications that present a significant risk to life or property.



<http://www.ccs-grp.com>
intlsales@ccs-inc.co.jp

Head Office
Shimodachiuri-agaru, Karasuma-dori
Kamigyo-ku, Kyoto 602-8011 Japan
Phone: +81-75-415-8284, Fax: +81-75-415-8278

B0839-0020-A

No. MP-097E Apr. 2006